

# ➤ Instructions

## Thule Approach Awning 901851, 901853





➤ **Video Instructions**  
Thule Approach Awning

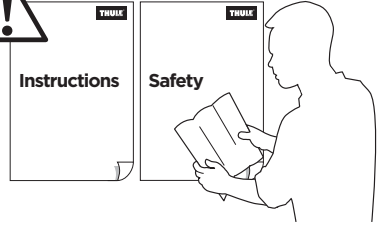
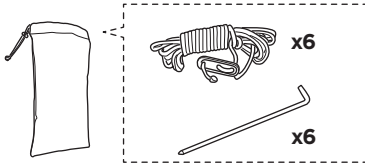
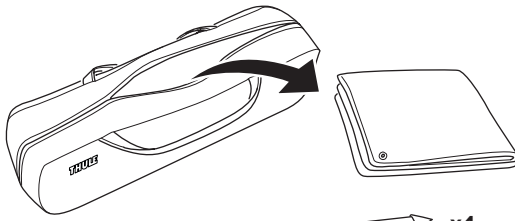

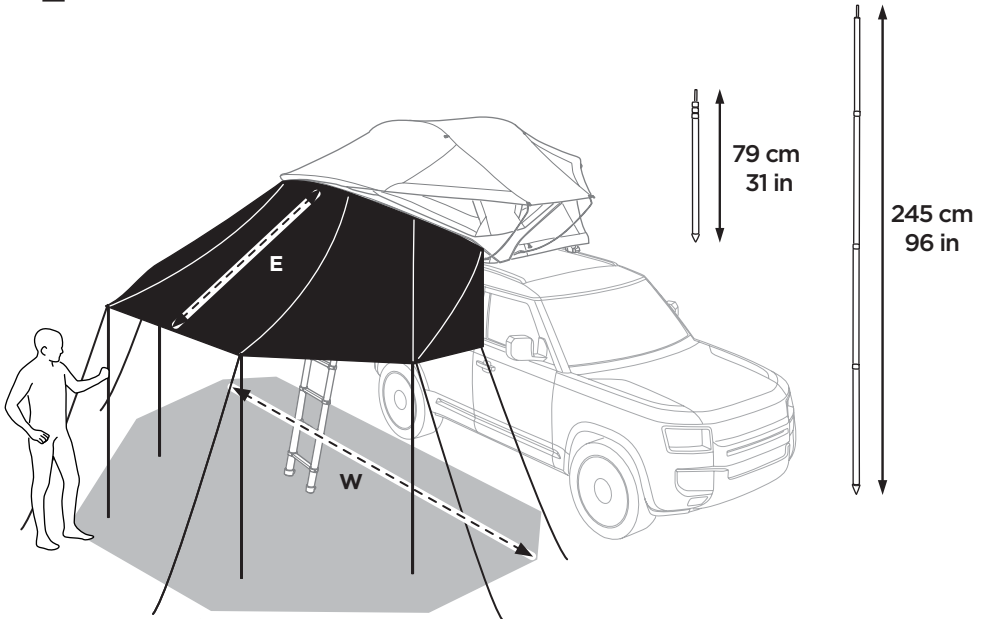

**i**



	Weight	Dimensions Open E x W
 <b>Thule Approach Awning S/M</b> 901851	4 kg 9 lbs	210 x 400 cm 83 x 160 in
 <b>Thule Approach Awning L</b> 901853	4.1 kg 9 lbs	210 x 400 cm 83 x 160 in

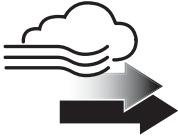

1

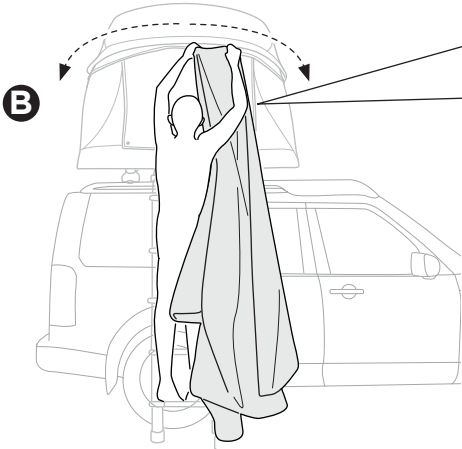

A

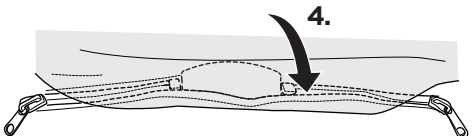
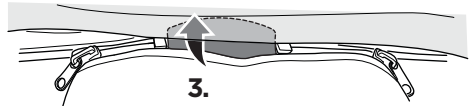
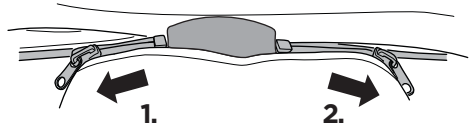

2

A

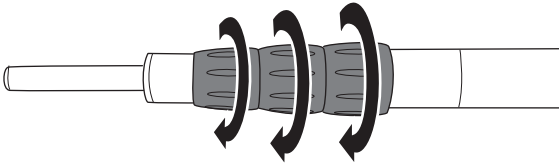

B

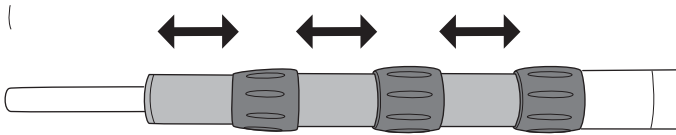

C

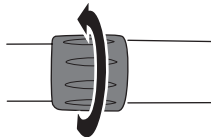

**3**



**A**

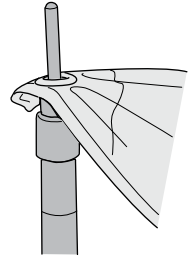
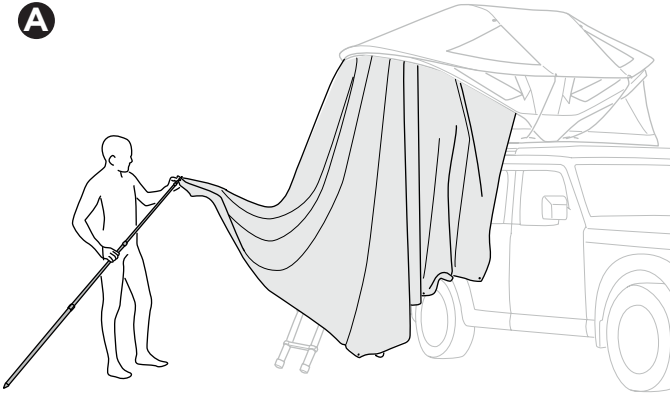

**B**

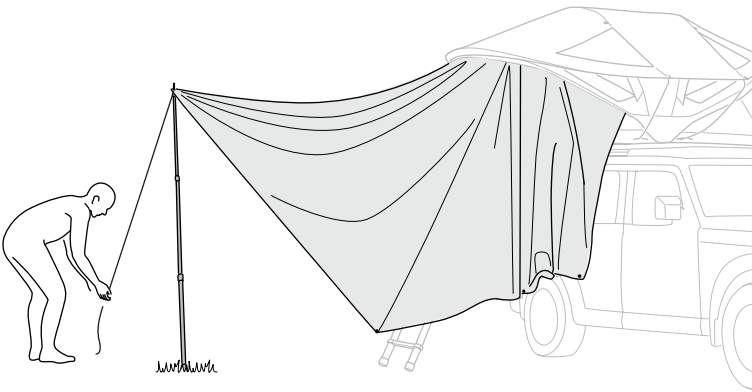

**C**

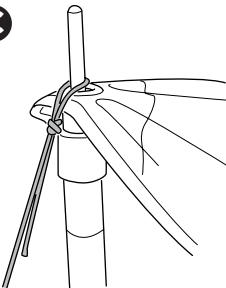

**D**

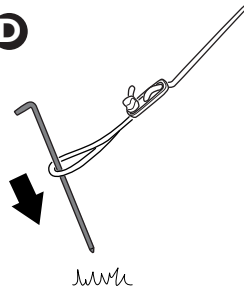

**E**

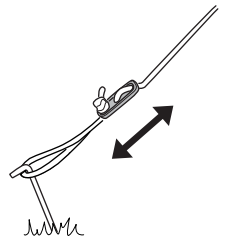

**x4**

4

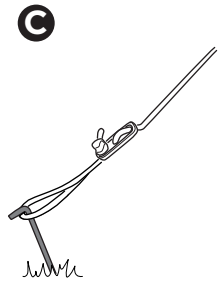
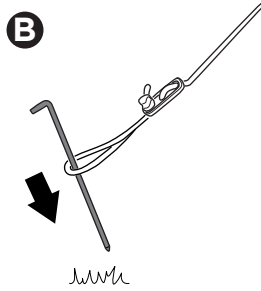
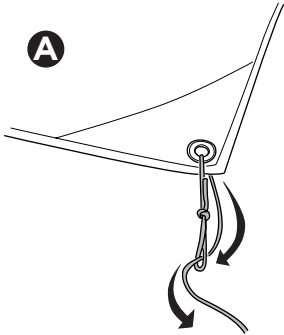
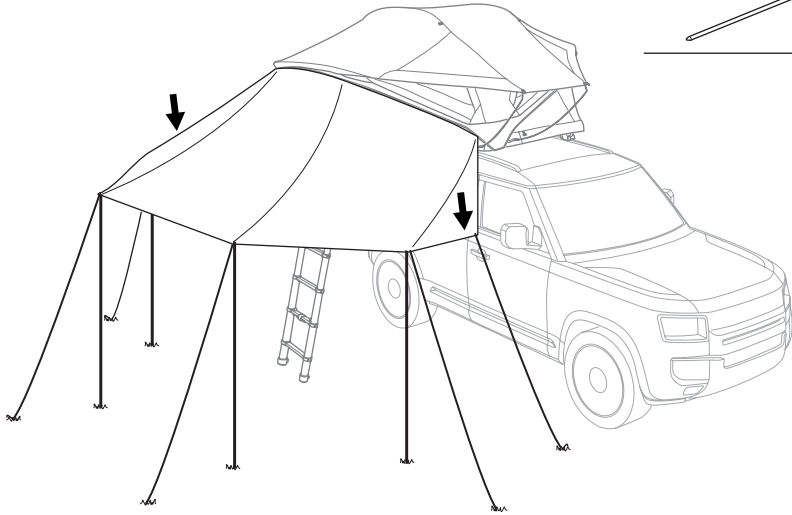

**i**

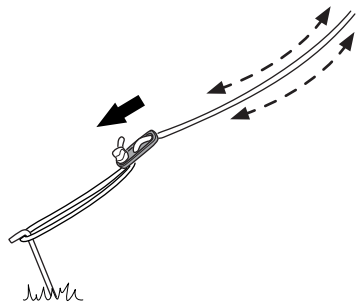
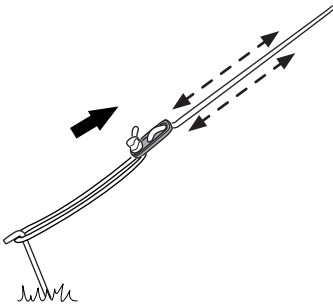

**i**



**A**

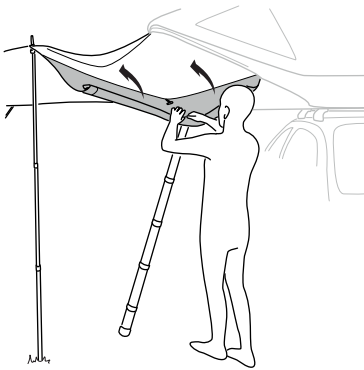

**B**

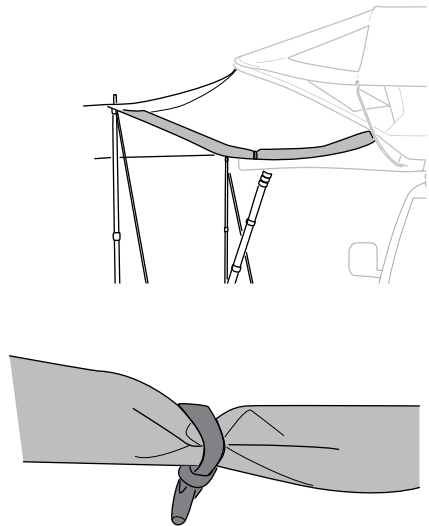

**i**

